

VOORGEVEL
BESTAAND.

VOORGEVEL
GEWIJZIGD.

ACHTERGEVEL
GEWIJZIGD.

ACHTERGEVEL
GEWIJZIGD.

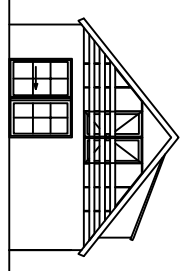

LINKERZIJGEVEL
BESTAAND.

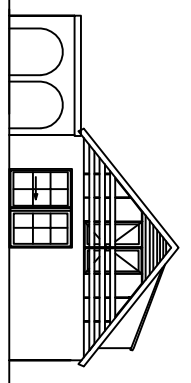

LINKERZIJGEVEL
GEWIJZIGD

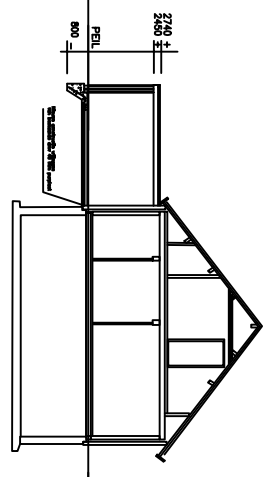

DOORSNEDEN A-A

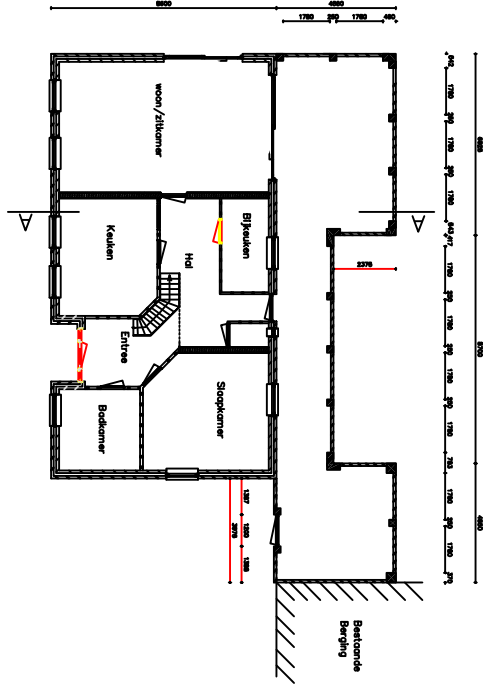

BEGANE GROND
BESTAAND.

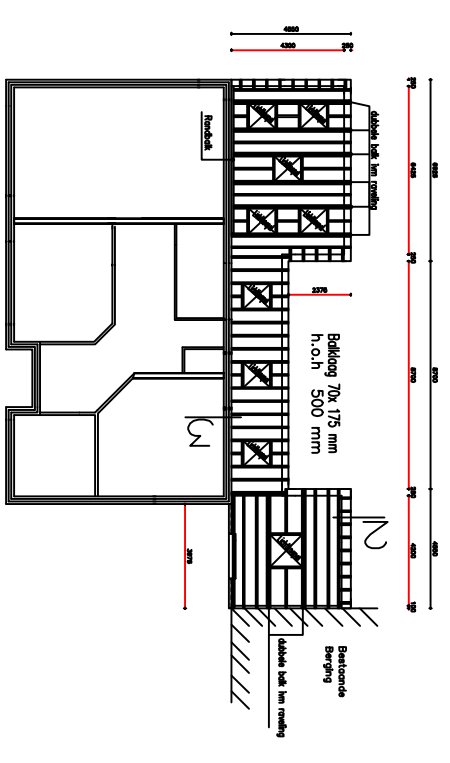

BALKLAAG.

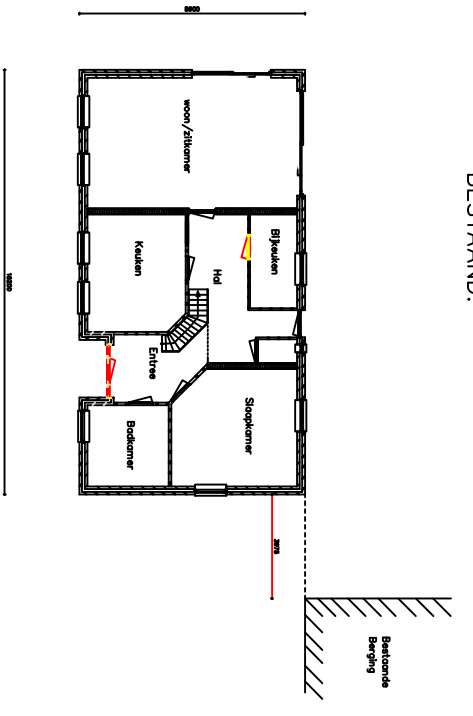

BEGANE GROND
GEWIJZIGD.

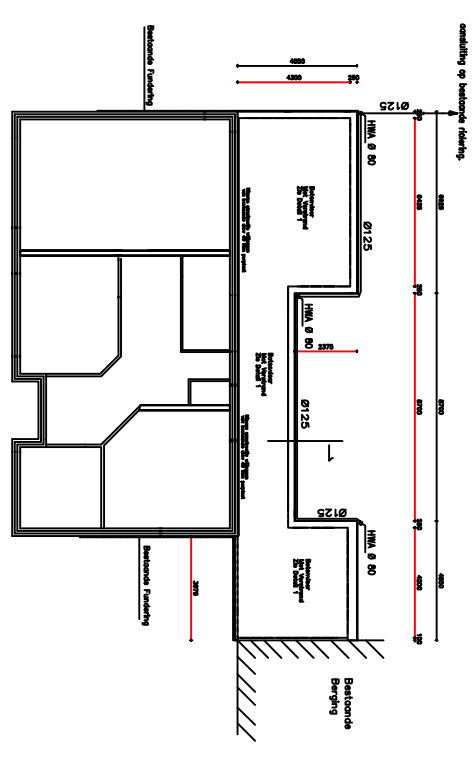

FUNDERING / RIOLERING

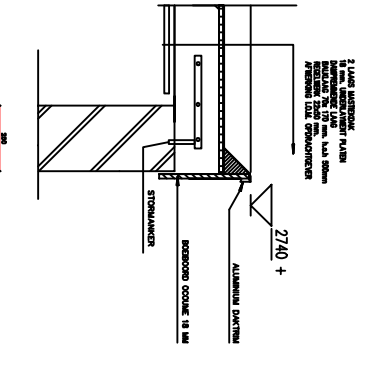

DETAIL 1

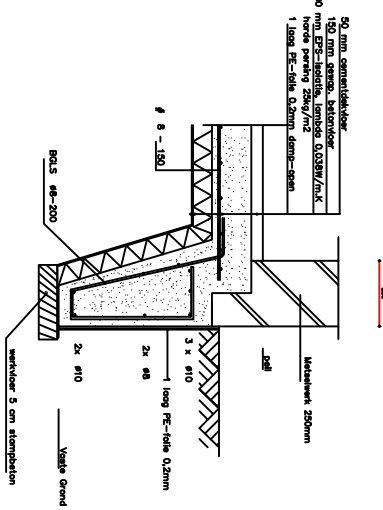

DETAIL 2

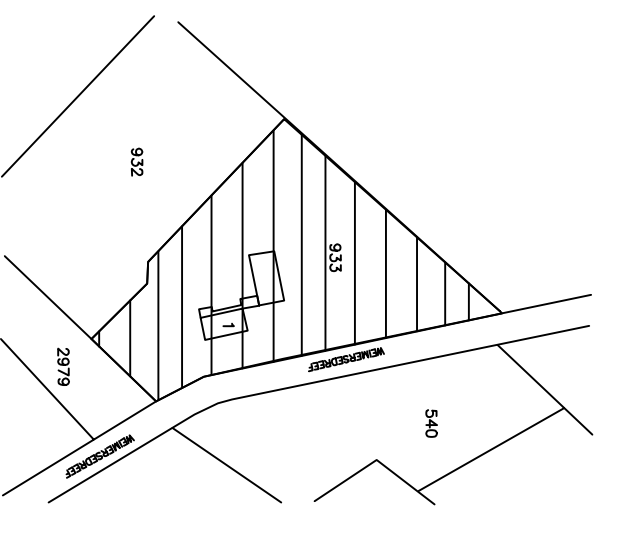

situatie:
Kadastrale gemeente : Prinsenbeek
Sectie: H
Perceelnummer: 933
Wettersedreef 1
4841 KG Prinsenbeek
Schaal: 1 : 500

BESTEKTEKENING		
Form. A, v.d. Boven		
Wettersedreef 1		
4841 KG Prinsenbeek		
Wettersedreef 1		
4841 KG Prinsenbeek		
Archi/bouwkantoor	0807	01
De Oever 4, Laan	1:100 / 1:10	
Mobile: 06-28403112		
KVK Binnendienst		
KVK Binnendienst		