

Achtergevel
BESTAANDE SITUATIE

V.R.1.m. Ventilatiekooster
Riet Riet 600 wit.

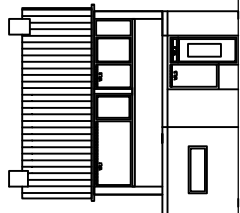

Achtergevel
GEWIJZIGDE SITUATIE

V.R.2.m. Ventilatiekooster
Riet Riet 600 wit.

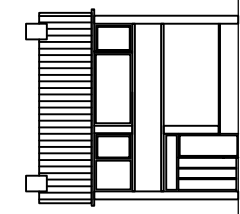

Voorgevel
BESTAANDE SITUATIE

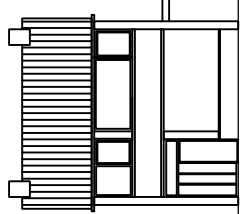

Voorgevel
GEWIJZIGDE SITUATIE

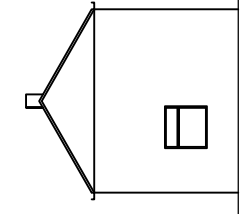

Voorgevel
BESTAANDE SITUATIE

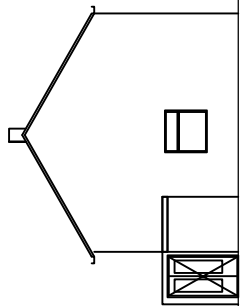

Zijgevel
GEWIJZIGDE SITUATIE

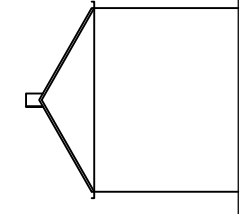

Zijgevel
BESTAANDE SITUATIE

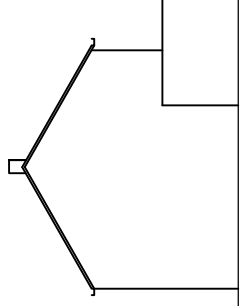

Rechter Zijgevel
BESTAANDE SITUATIE

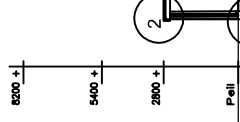

Rechter Zijgevel
GEWIJZIGDE SITUATIE

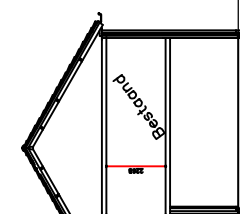

Doorsnede
GEWIJZIGDE SITUATIE

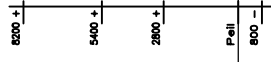

Paal

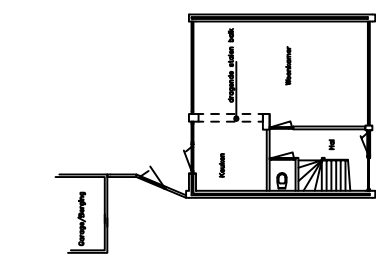

BEGANE GROND
BESTAAND.

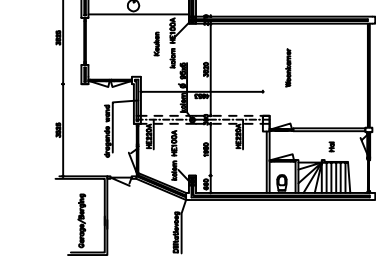

BEGANE GROND
GEWIJZIGD.

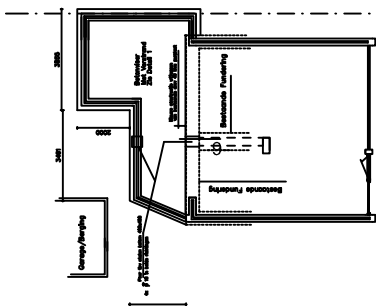

FUNDERING
GEWIJZIGD.

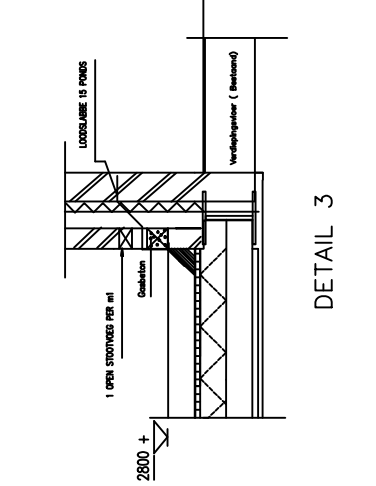

DETAIL 3

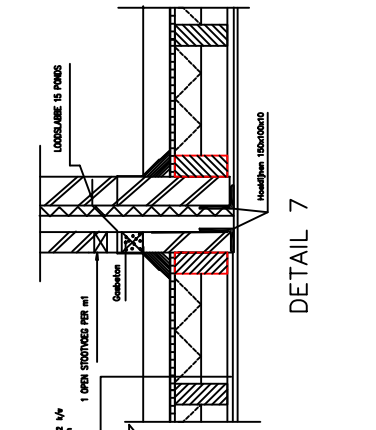

DETAIL 7

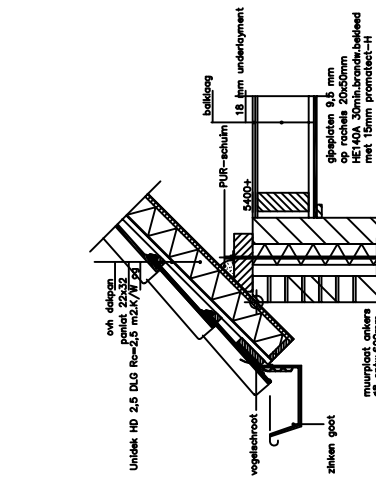

DETAIL 4

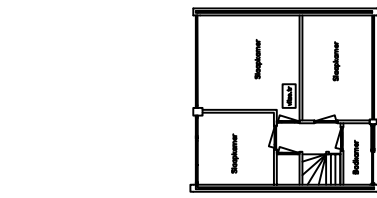

1e VERDIEPINGSVLOER
BESTAAND.

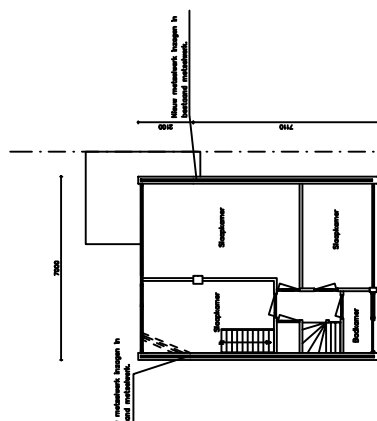

1e VERDIEPINGSVLOER
GEWIJZIGD.

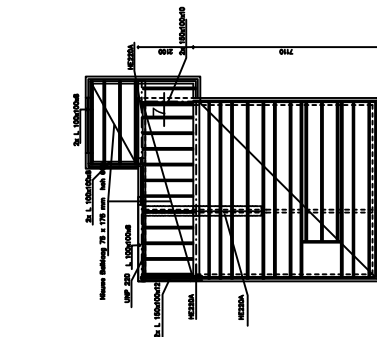

BALKLAAG
1e VERDIEPINGSVLOER
GEWIJZIGD.

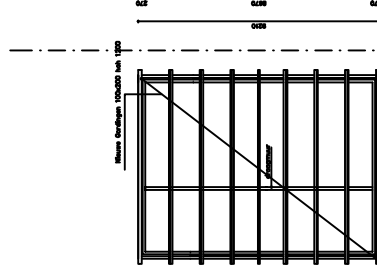

DAKPLAN
GEWIJZIGD

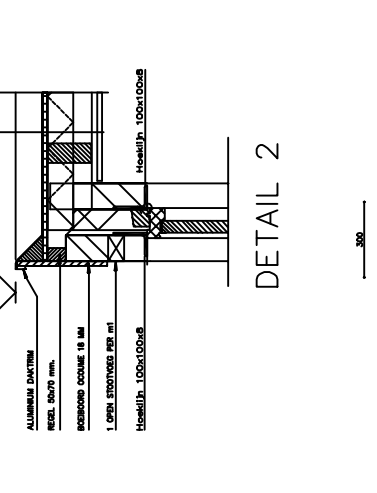

DETAIL 2

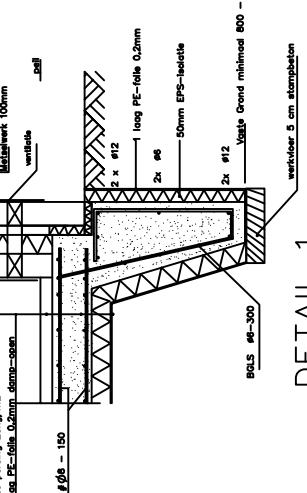
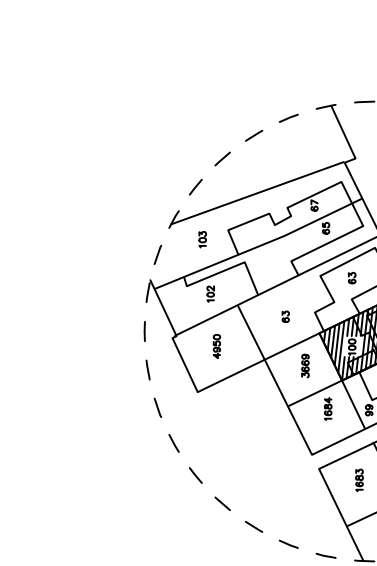

DETAIL 1

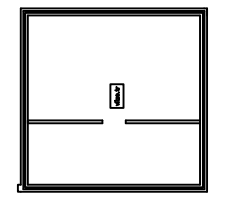

ZOLDERVLOER
BESTAAND.

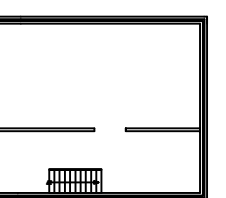

ZOLDERVLOER
GEWIJZIGD.

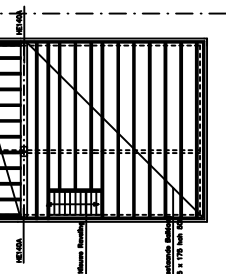

BALKLAAG
ZOLDERVLOER
GEWIJZIGD.

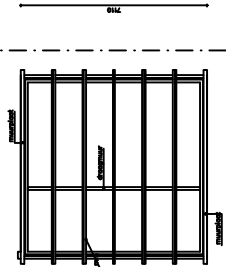

DAKPLAN
BESTAAND.

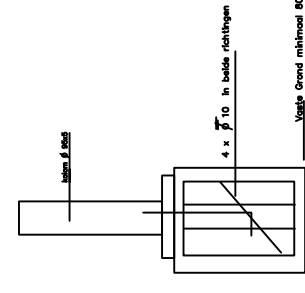

DETAIL 6

situatie:
Kadastrale Gemeente: Made
Sectie: S
Perceelnummer: 100
Zandstraat 61
4921 SL Made
Schaal: 1 : 500

BESTEKTEKENING
Form: R. Ewert
Afdeling: 61
4921 SL Made
Uitvoering: Beving
Zandstraat 61
4921 SL Made



0811
01

Titel	0811	Blad	1 : 100 / 1 : 10
Opsteller	R. Ewert	Ontwerper	J.M. van der Meulen
Uitvoerder	Beving	Bevestiging	Beving
Plaats	4921 SL Made	Projectnummer	19007234

Deze tekening blijft eigendom van J.M. van der Meulen - architectuurwerkplaats.