

Bestaand:	Bruto m2 vloeropp., Begane grond 80 m2
Gewijzigd:	Bruto m2 vloeropp., Begane grond 92 m2

Bestaand:	Bruto m2 vloeropp., verdieping 44 m2
Gewijzigd:	Bruto m2 vloeropp., verdieping 63 m2

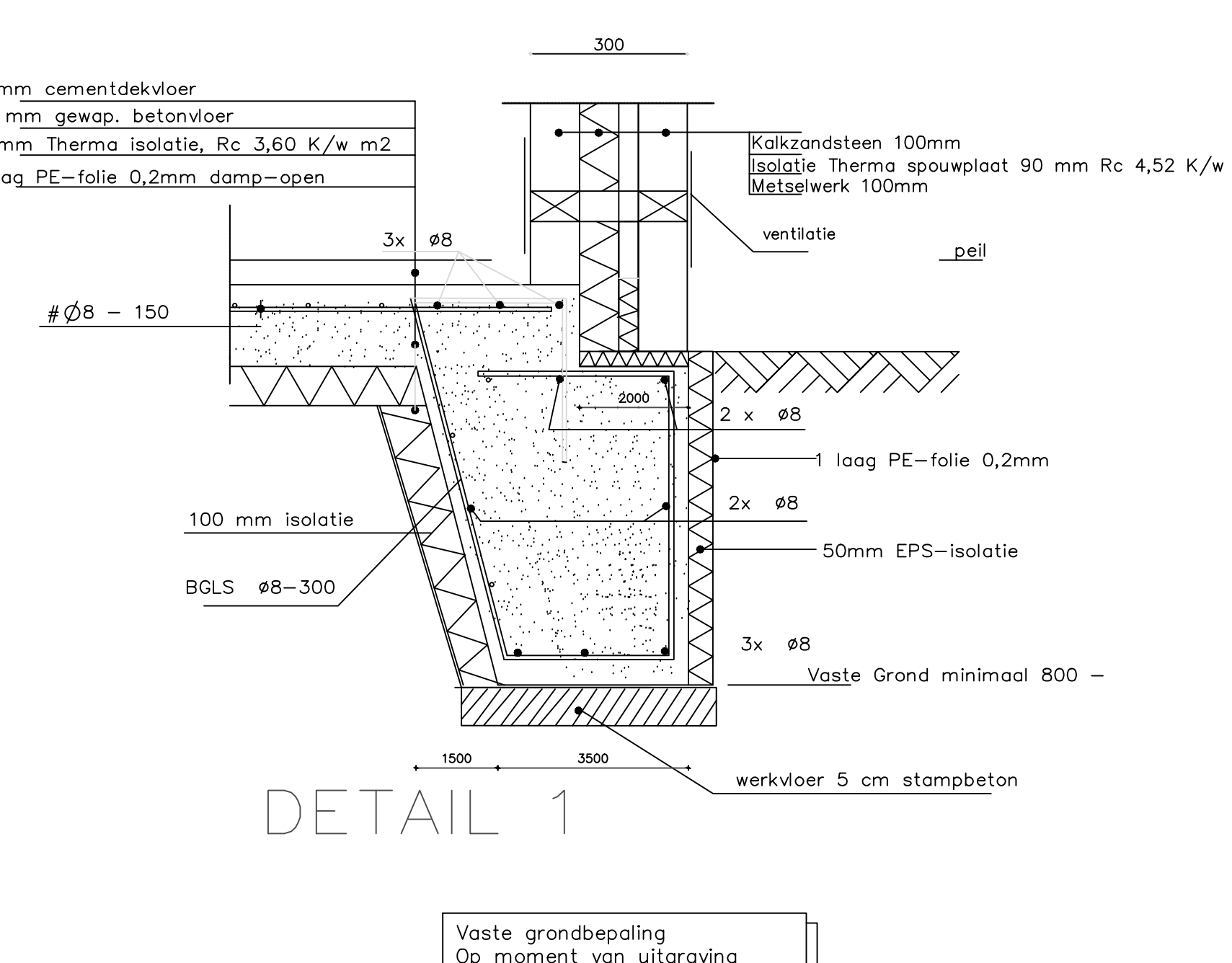
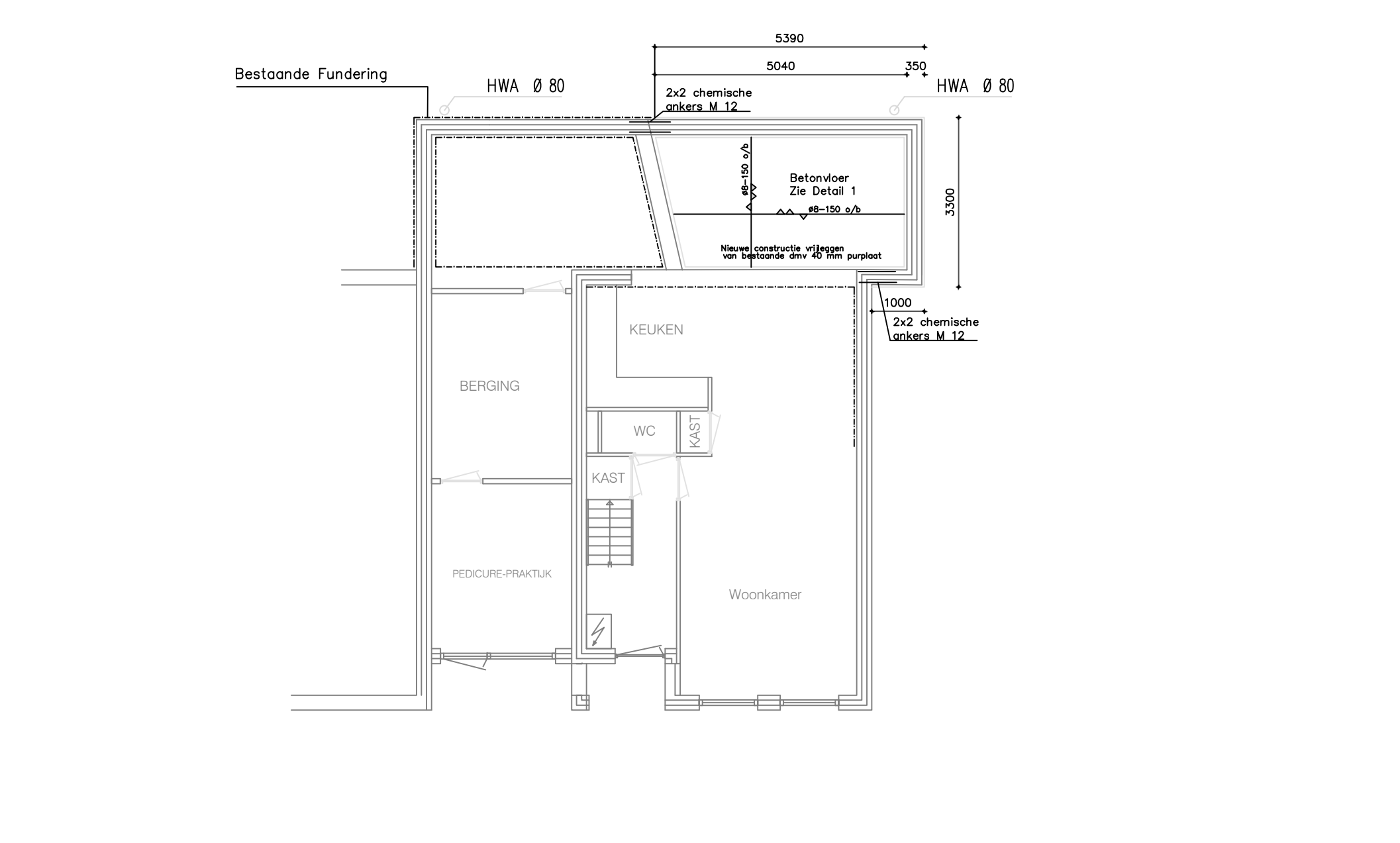
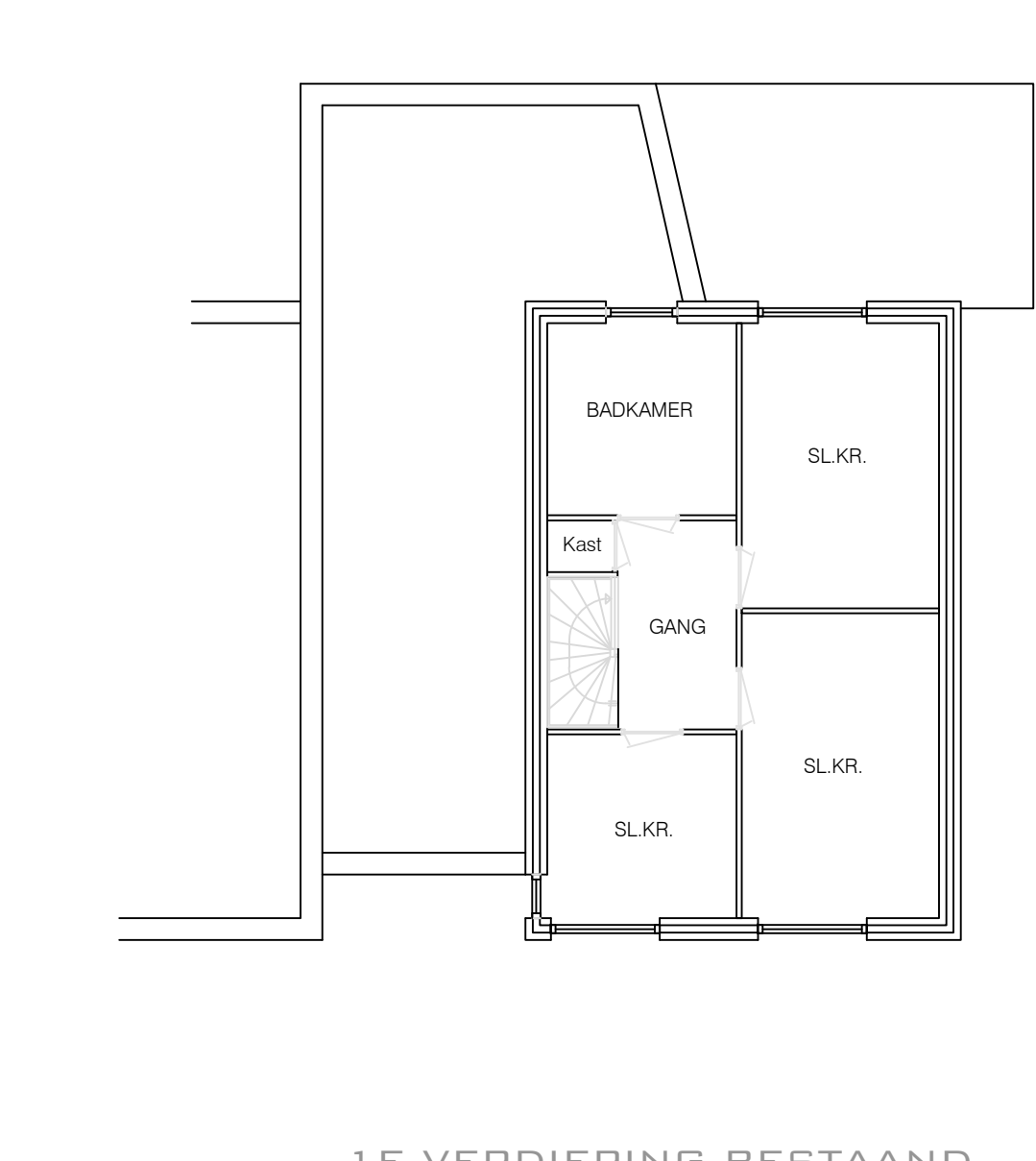
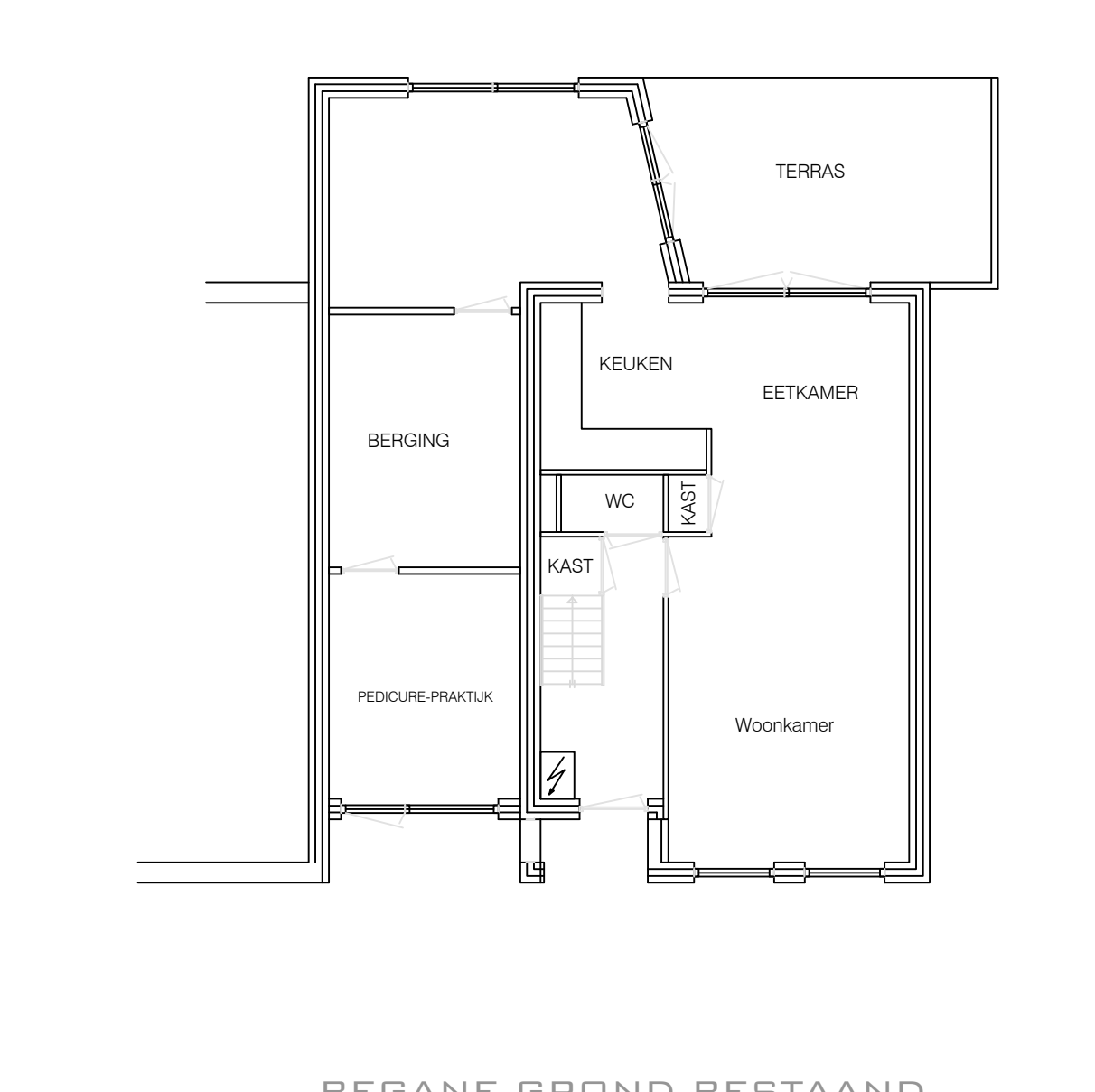
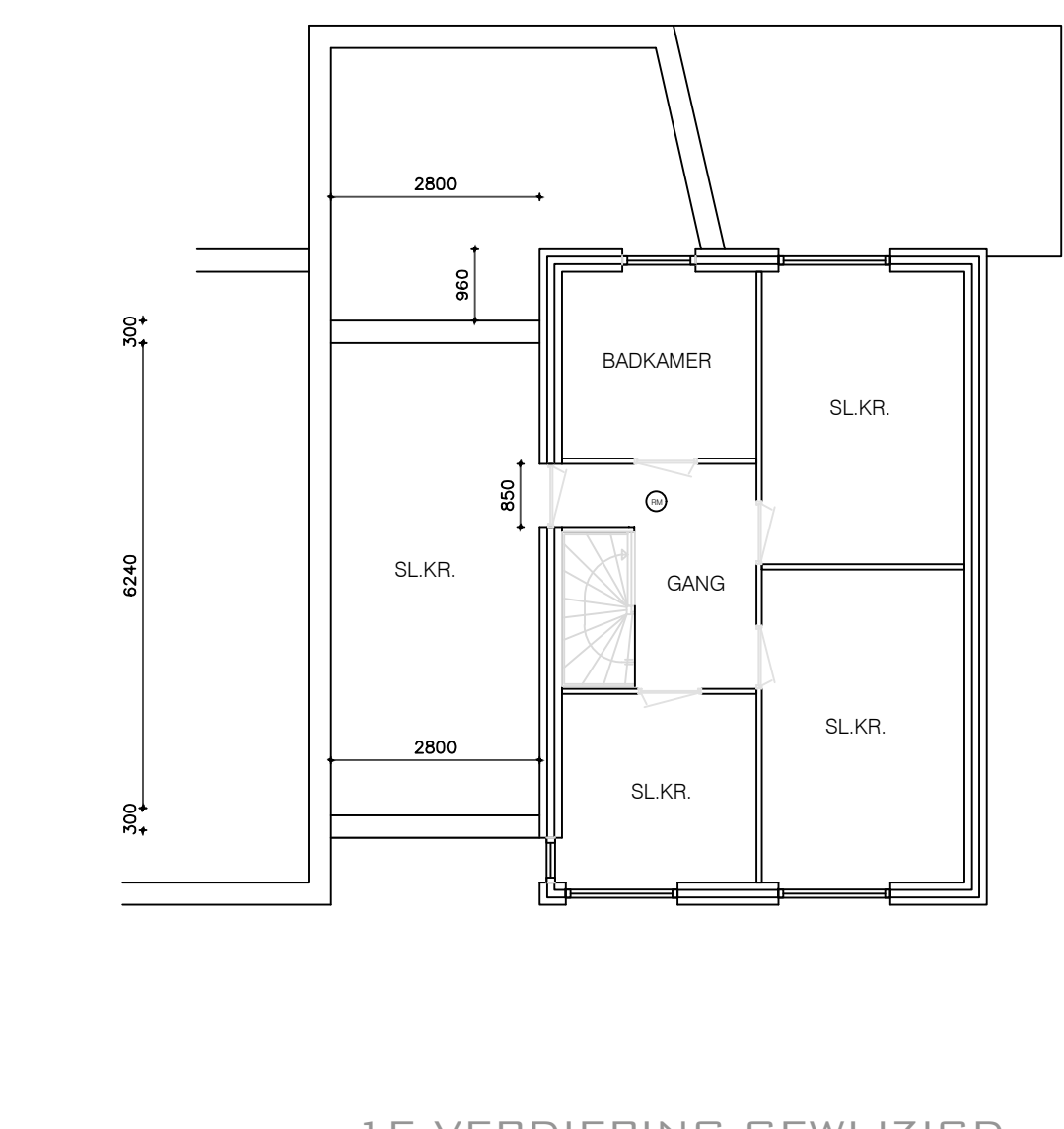
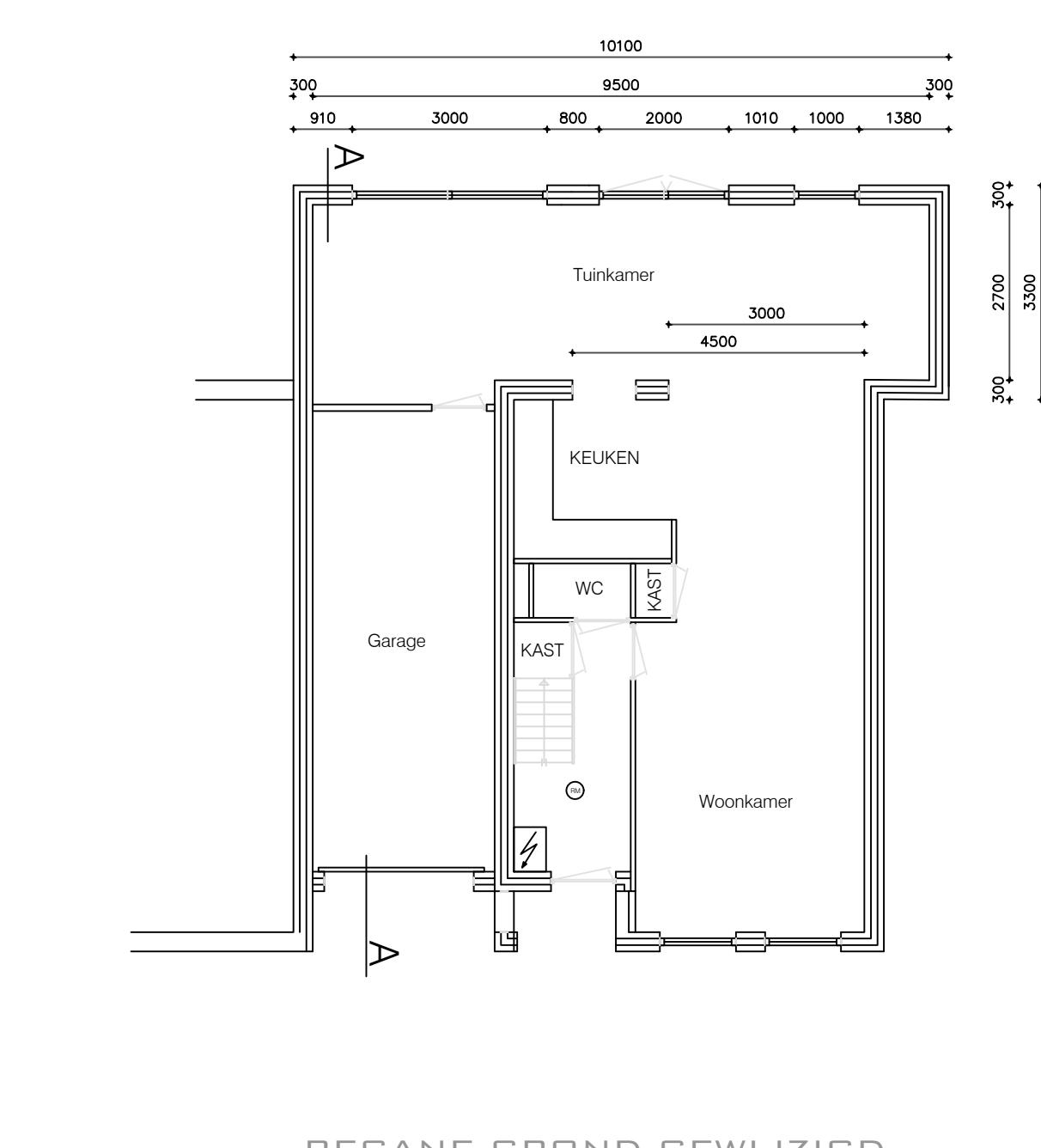
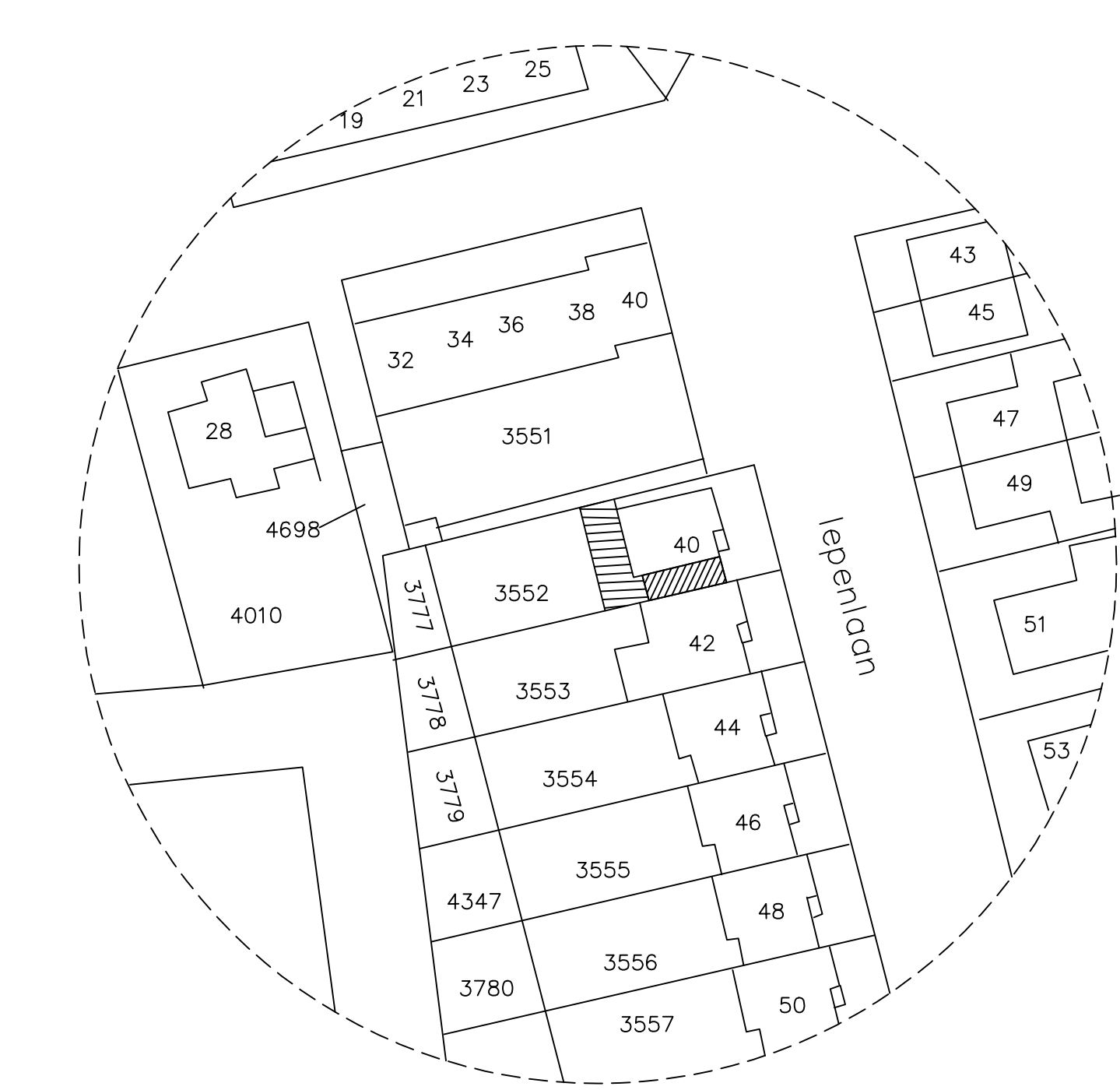
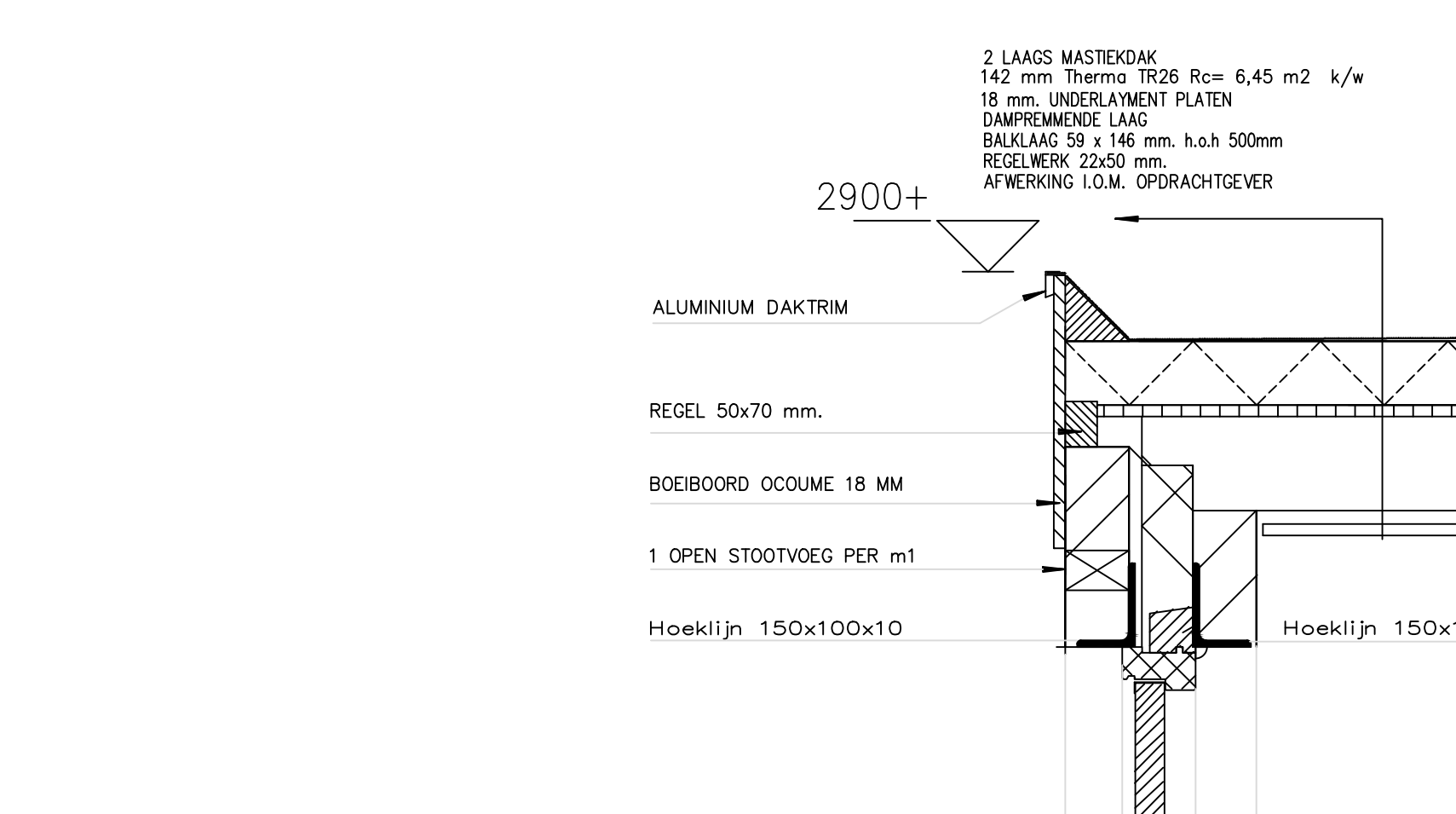
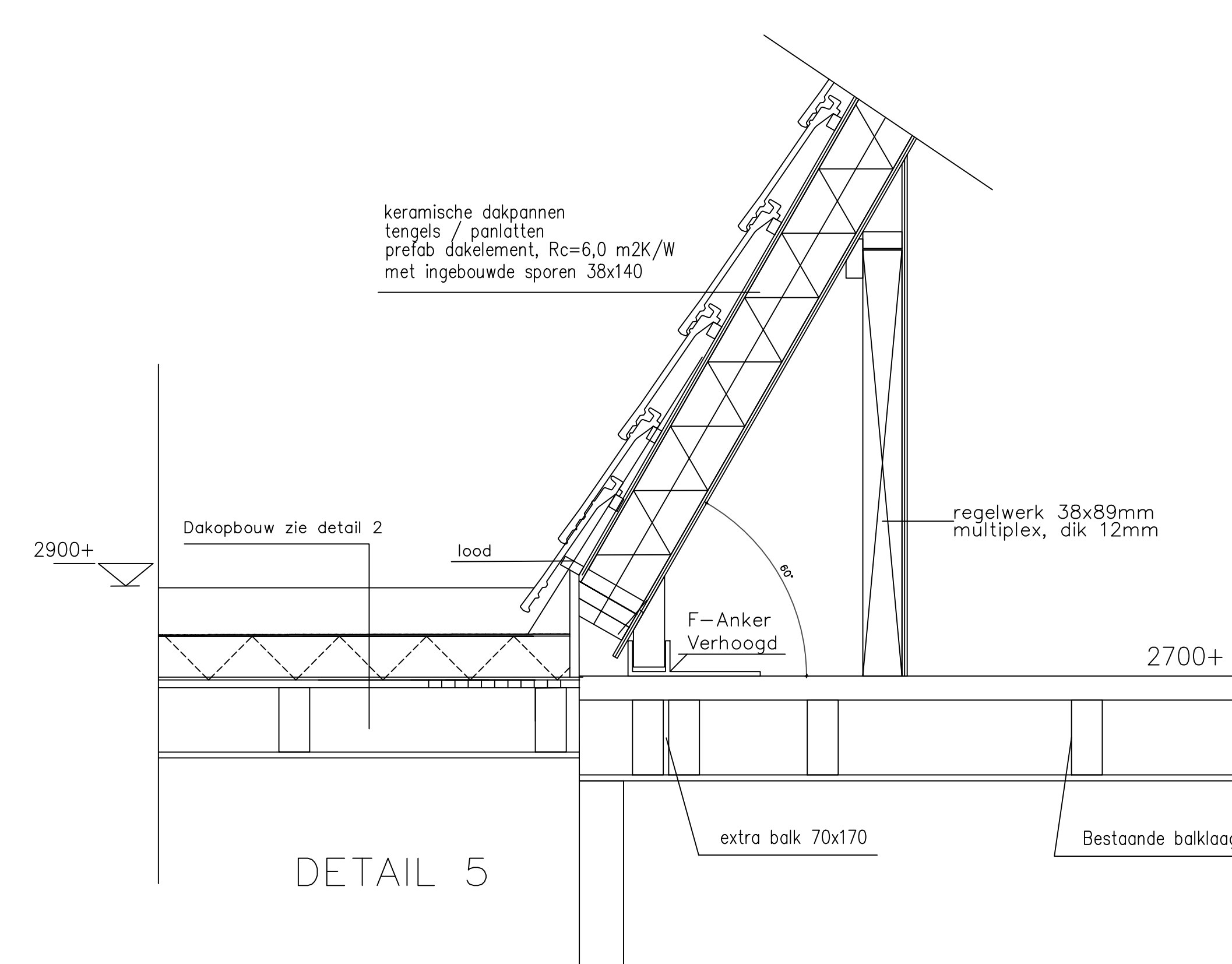
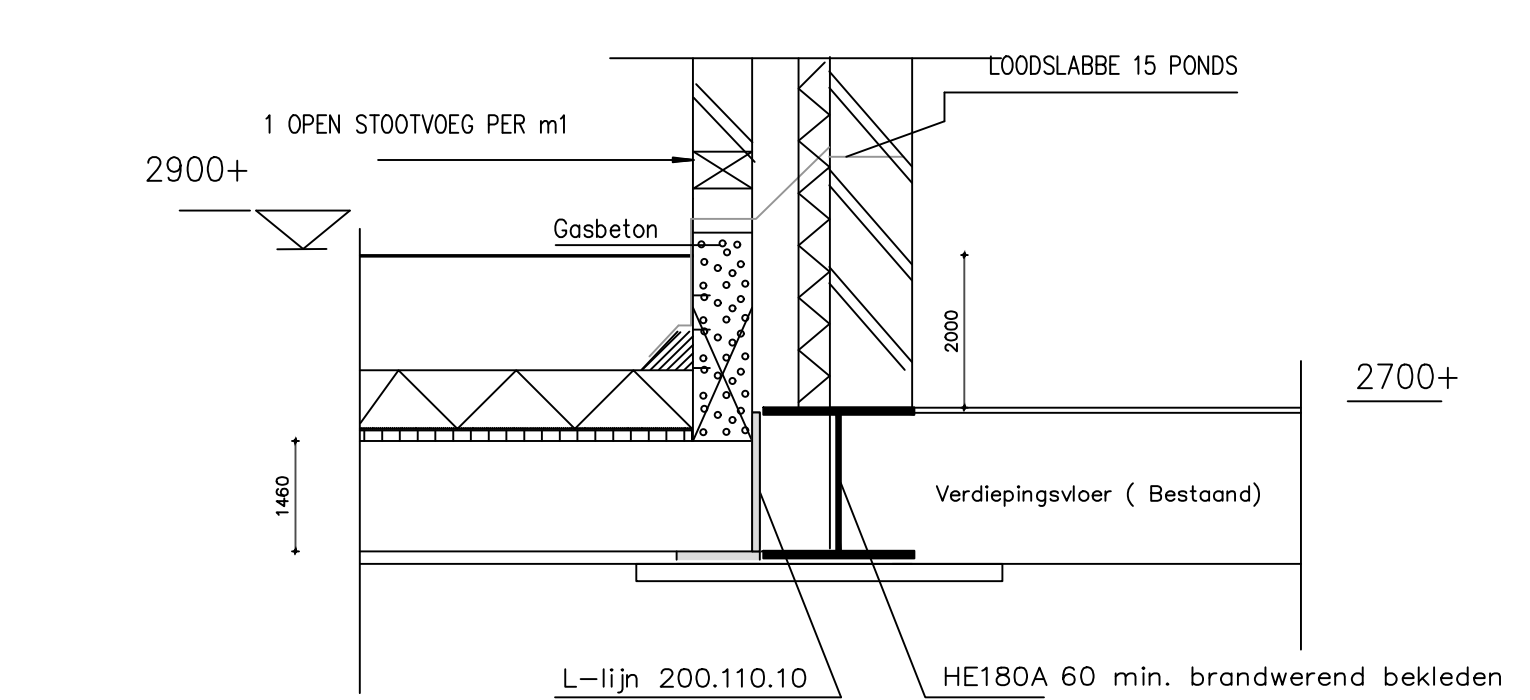
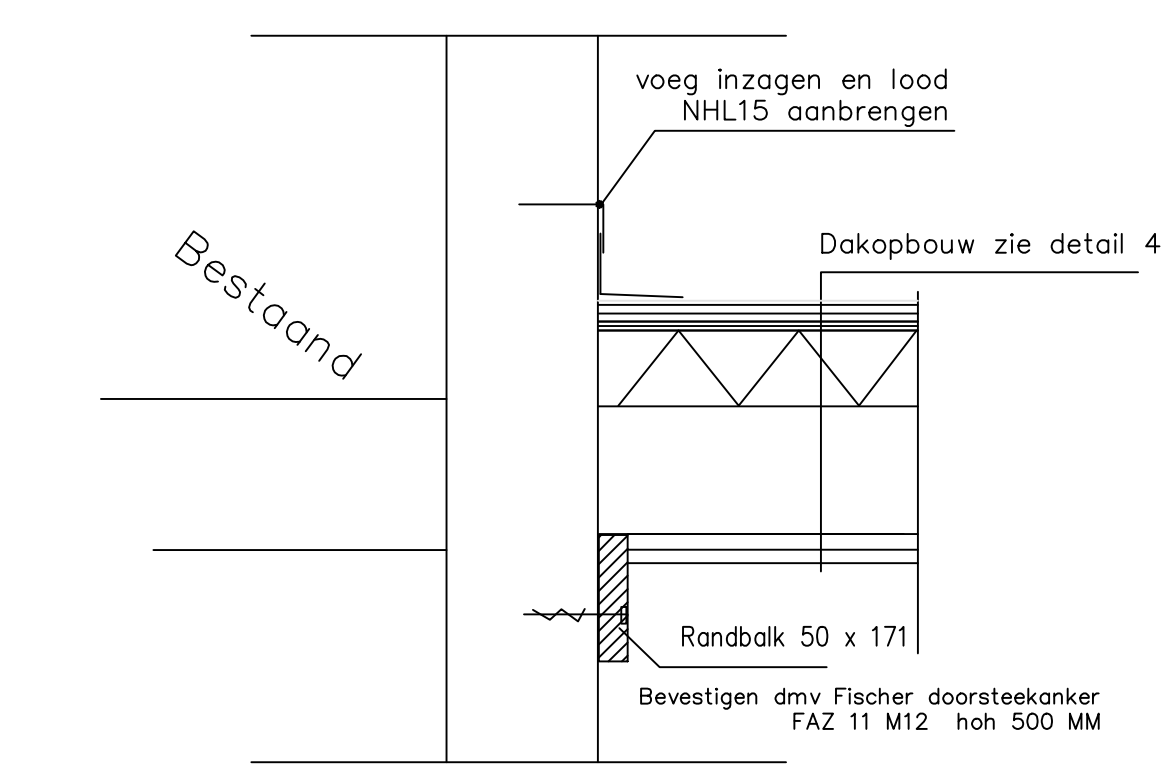
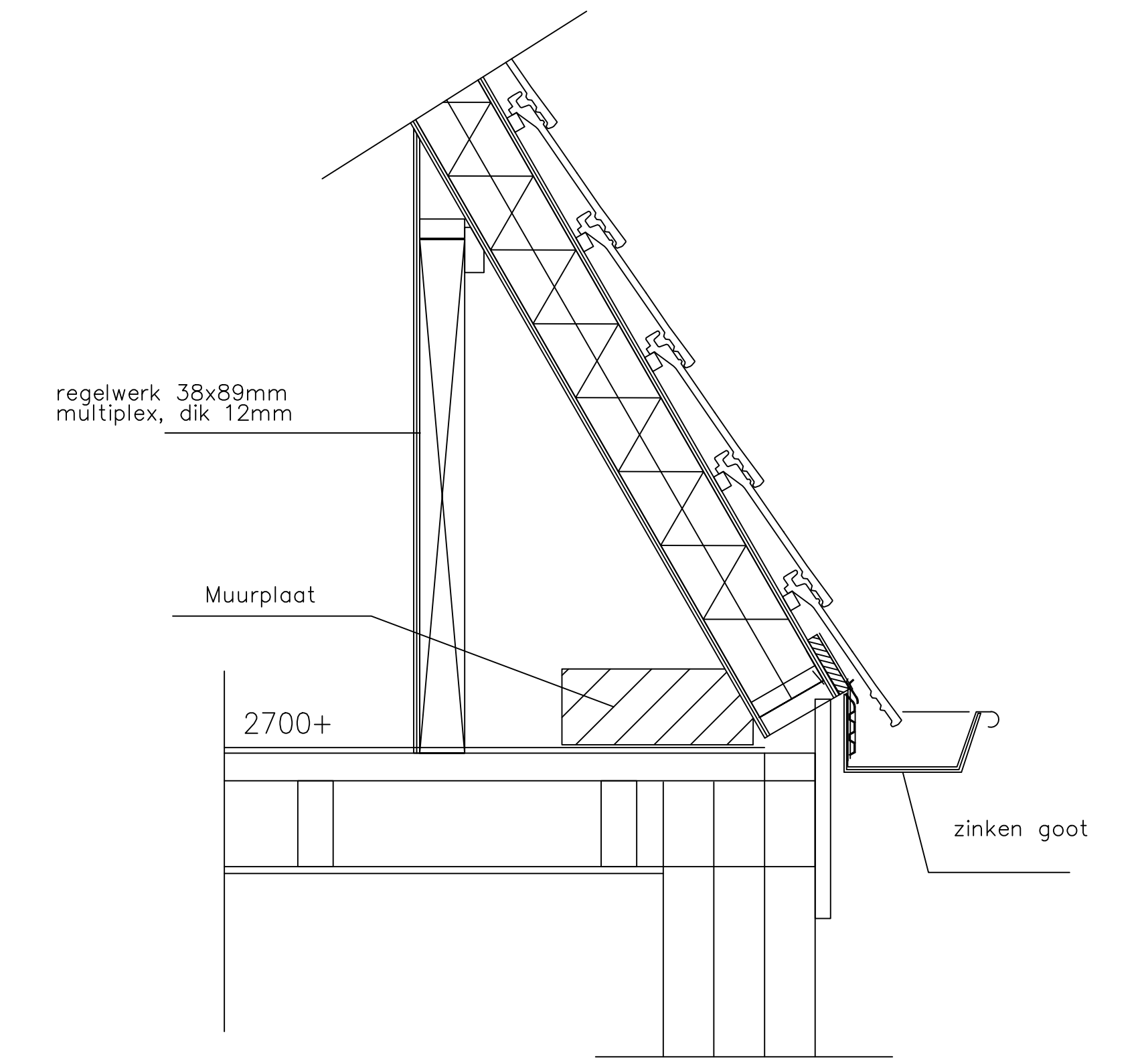
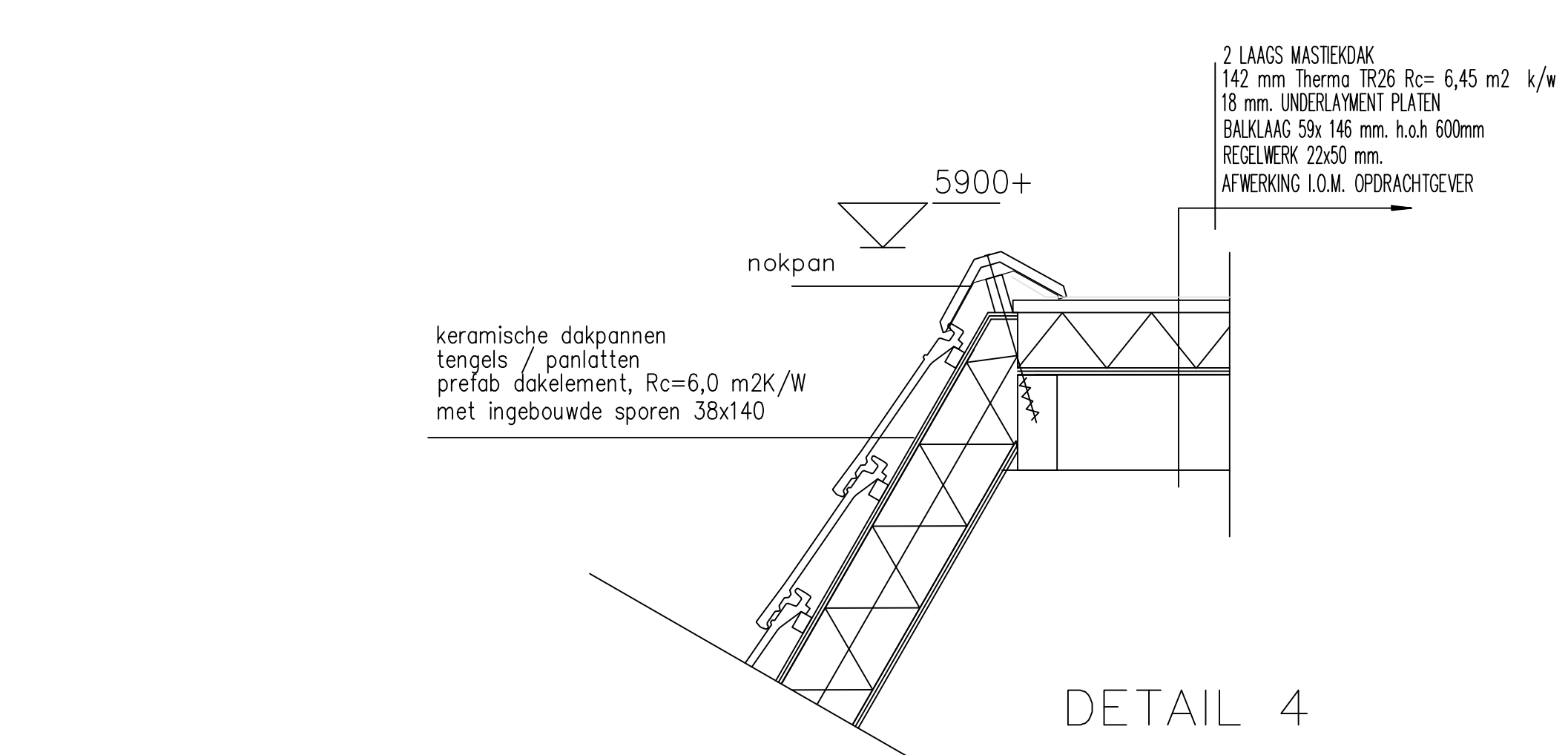
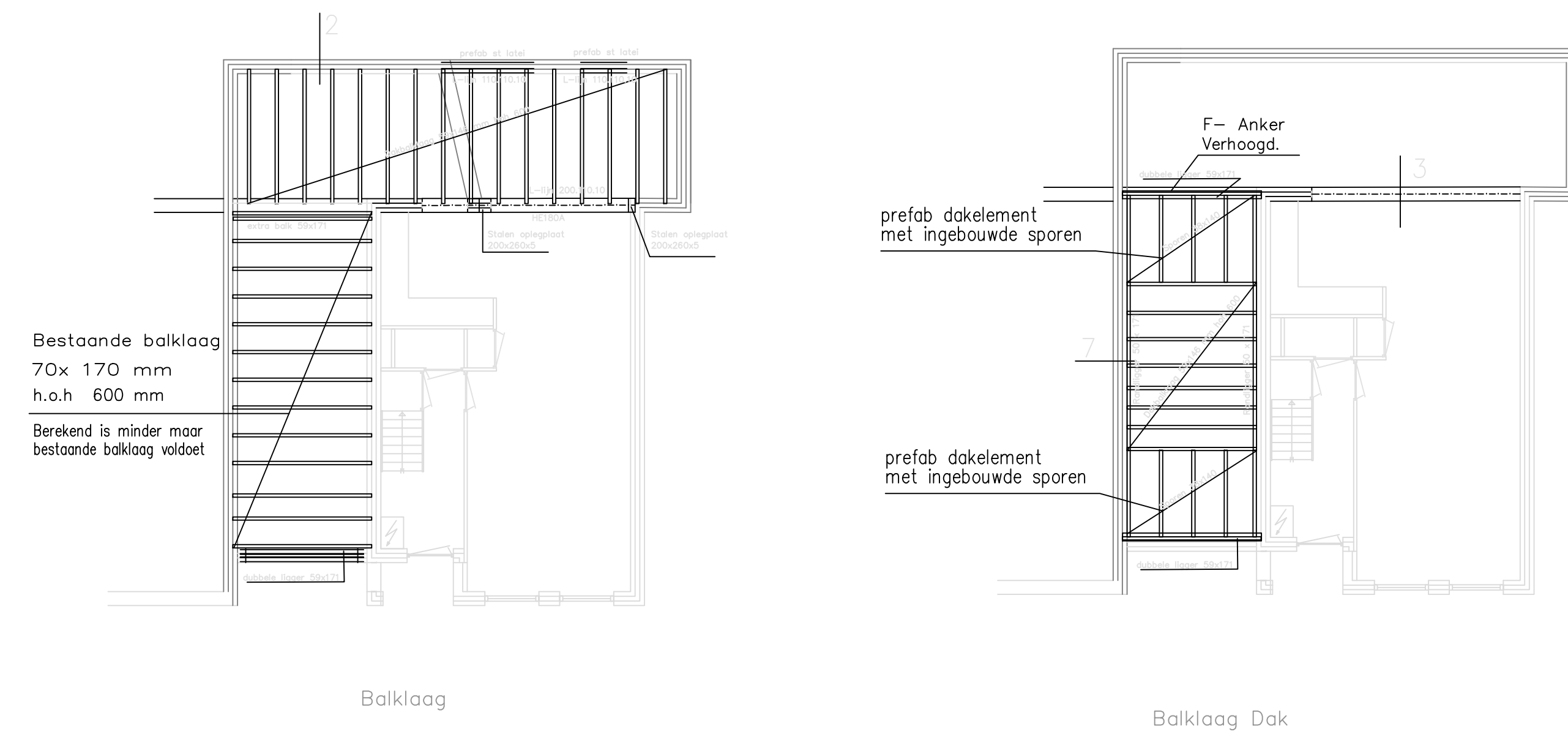

situatie.
Kadastrale Gemeente: Made
Sectie: S
Perceelnummer: 3552
Iepenlaan 40
4921 DR Made
Schaal: 1 : 500

onderdeel:	Bestektekening		versie:	16.18
opdrachtgever:	Firm. M. Brouwer Iepenlaan 40 4921 DR Made			
werk:	Uitbreiding begane grond + 1e verdieping Iepenlaan 40 4921 DR Made			
JVMTEKENBUREAU	datum: 30-10-2018	schaal:	1 : 100 / 1 : 10	
De Gijster 4 - Made	A : 20-11-2018	get.	JM	
Mobiel: 06-28953112	B : 22-11-2018	D :		
www.jvmtekenbureau.nl	C :	H :	formaat: A0	
KvK Breda: 18087234	D :	H :		

Alle juiste detaillering worden IHW bekeken en bepaald.

Deze tekening blijft eigendom van jvmtekenbureau - auteursrecht voorbehouden.